

COBERTURA
escala 1:100

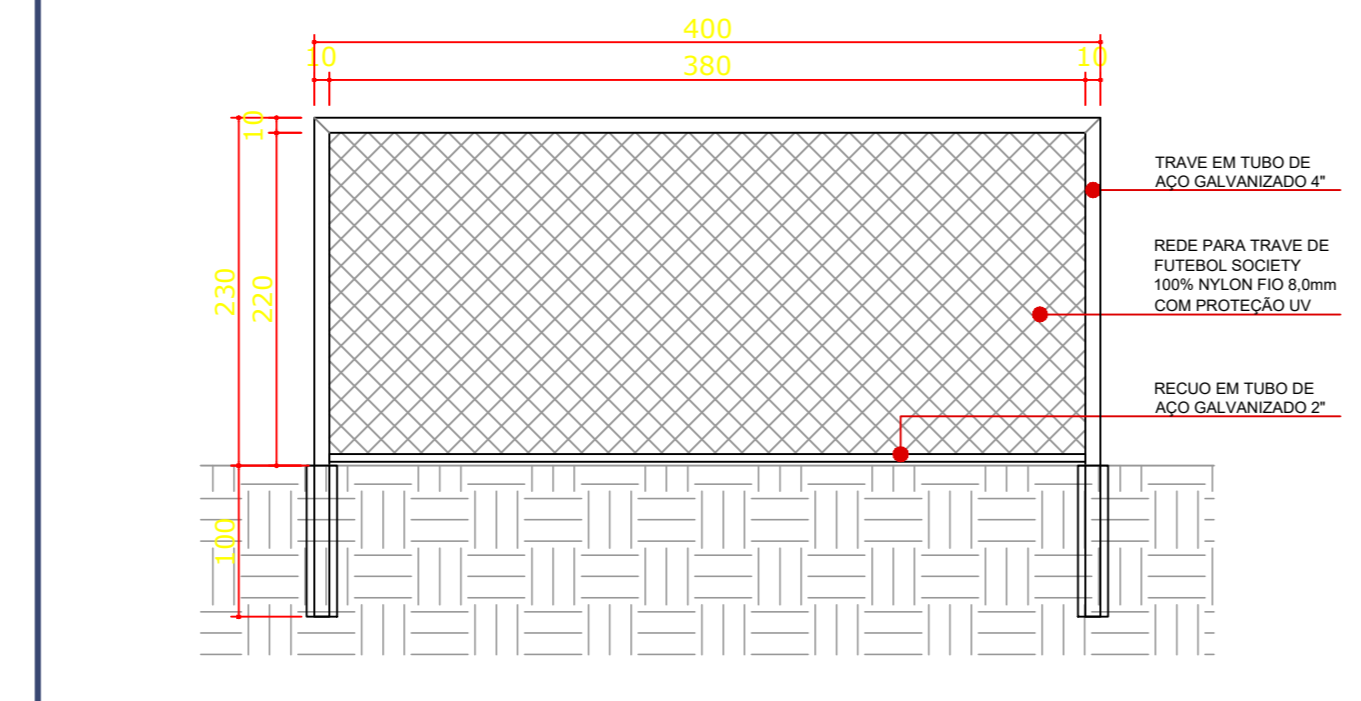

VISTA TRAVE
sem escala

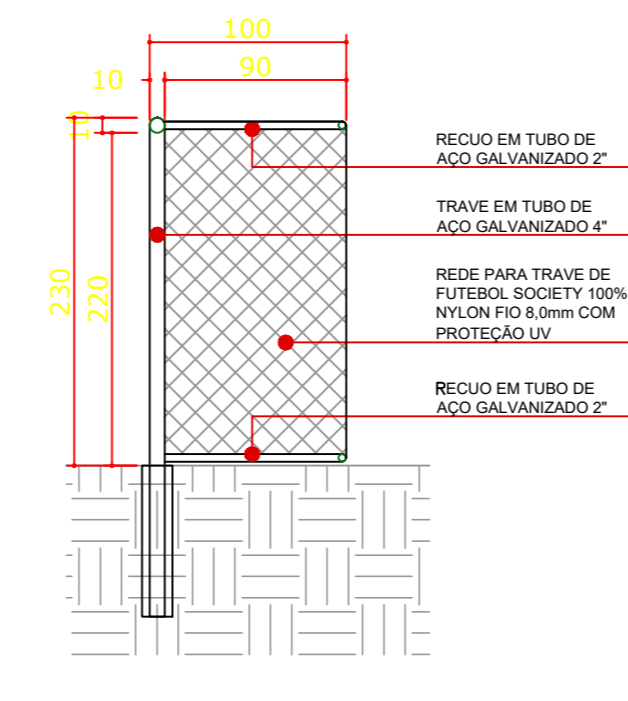

CORTE TRAVE
sem escala

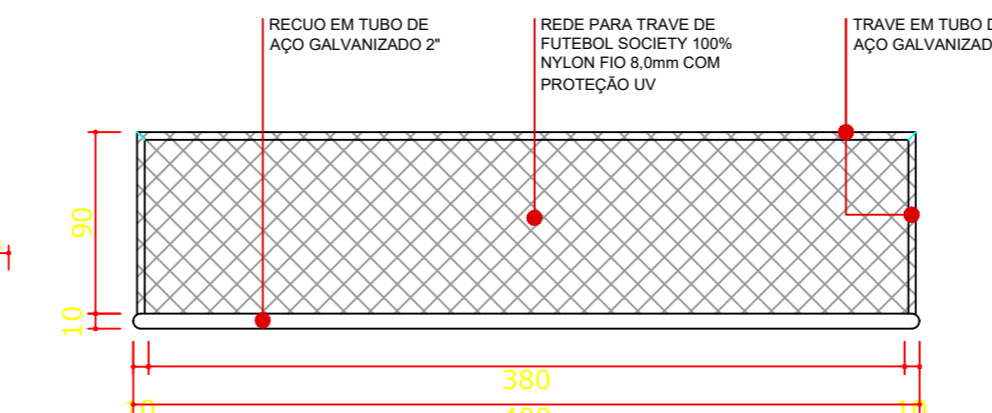

PLANTA TRAVE
sem escala

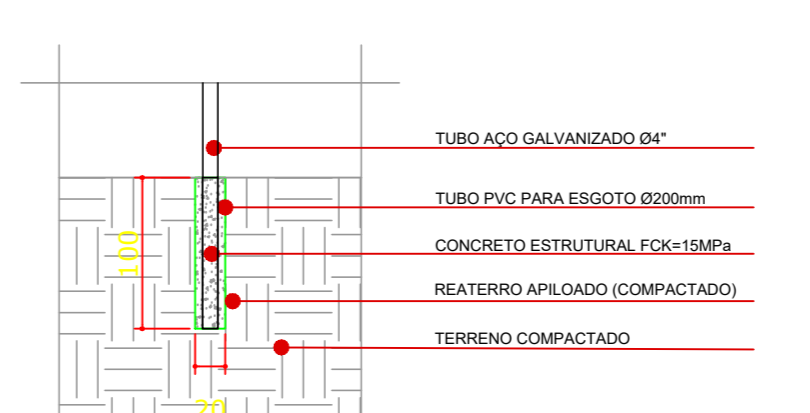

FUNDAÇÃO TRAVE
sem escala

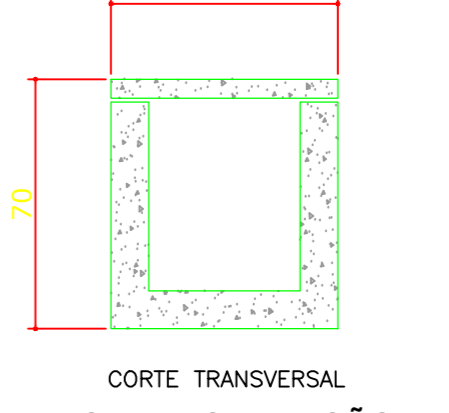

CORTE TRANSVERSAL CAIXA CAPTAÇÃO em Concreto
sem escala

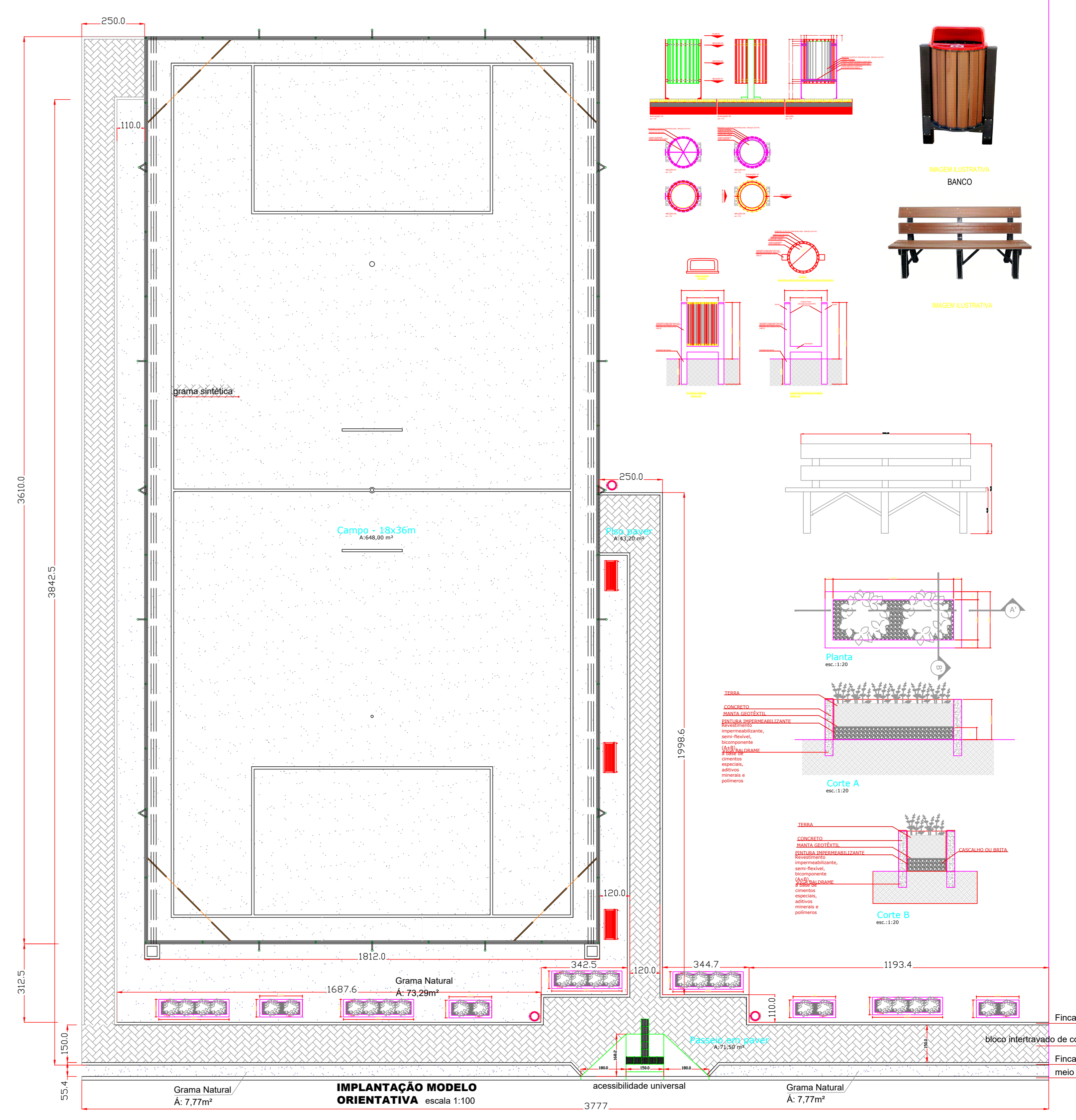

IMPLANTAÇÃO MODELO ORIENTATIVA
escala 1:100

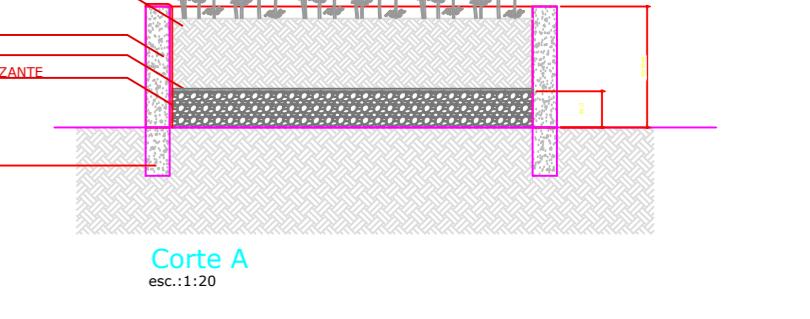
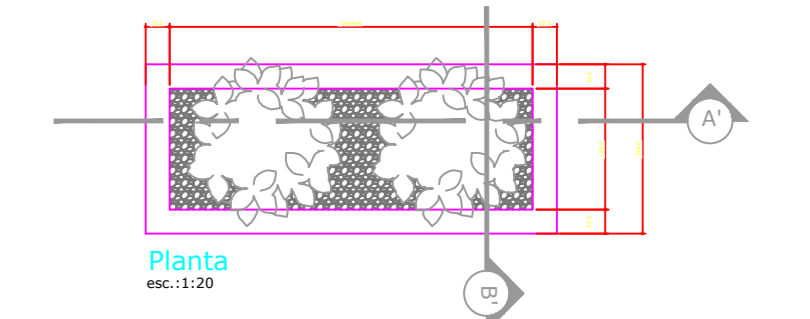
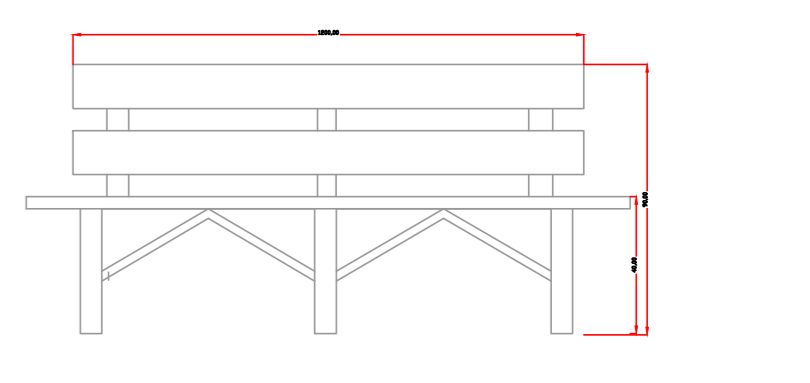
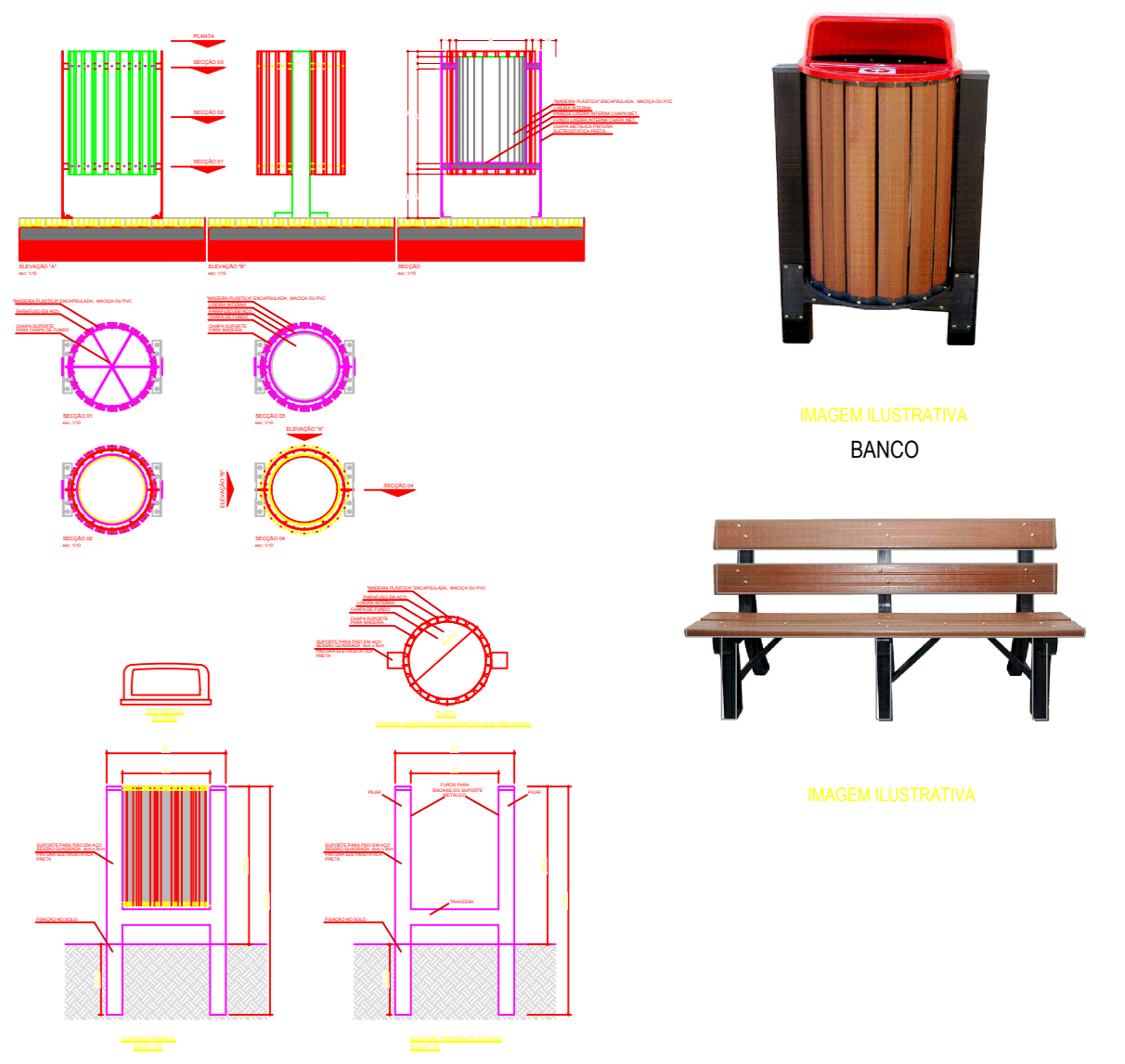

Corte A
esc: 1:20

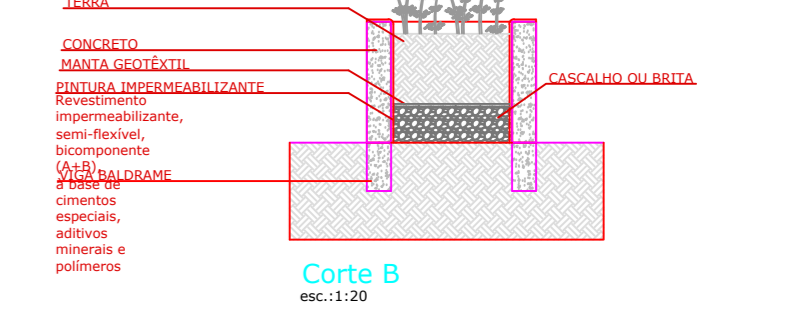

Corte B
esc: 1:20

TOTAL GRAMA SINTÉTICA: 648,00M²
TOTAL GRAMA NATURAL: 88,83M²
TOTAL BLOCO INTERTRAVADO (PAVER): 71,50M²

Secretaria de Estado do Desenvolvimento Urbano Serviço Social Autônomo PARANACIDADE	
PROJETO: QUADRA GRAMA SINTÉTICA	Planta: ARQUITETÔNICO
REFERÊNCIA: PLANTA DE COBERTURA IMPLANTAÇÃO MODELO	Nº Folha: 02/05
DETALHE TRAVE DETALHE CAIXA CAPTAÇÃO DETALHE BANCOS E LIXEIRA	Escala: INDICADA
	Data: fevereiro/2018
	Alterado em: 24/02/2018
PROJETO: Bruno Henrique de Oliveira Reghin - engenheiro civil	CREA PR 129992/D